



▶ DELTA SERİSİ / SERIES

KÜPEŞTE CAM SİSTEMLERİ
RAIL GLASS SYSTEM

www.elizcam.com.tr





Hayata *mutlu* bir iz...
Leave a *happier* mark on life...



DELTA SERİSİ / SERIES

KÜPEŞTE CAM SİSTEMLERİ
RAIL GLASS SYSTEM



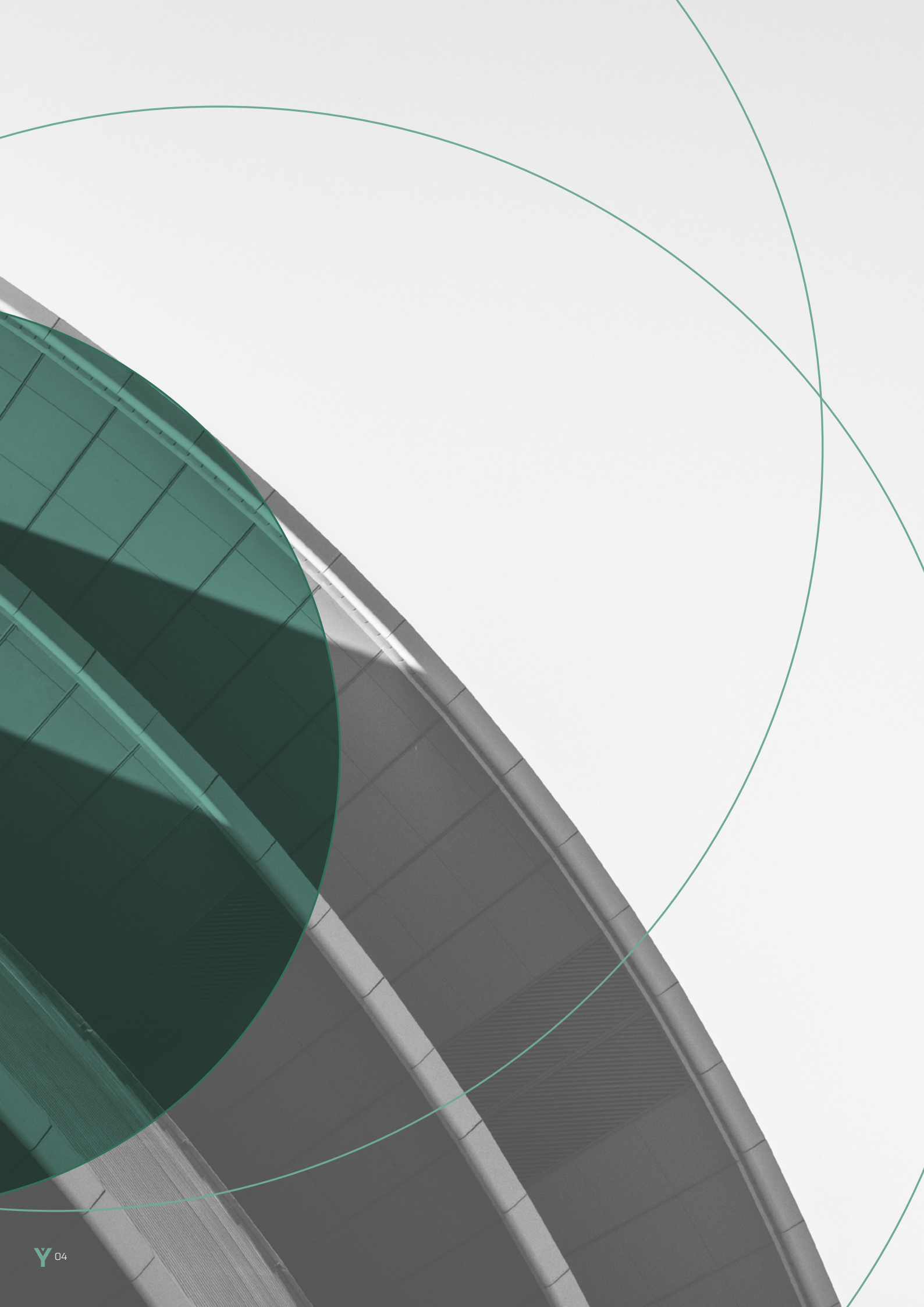

HAKKIMIZDA

İnsan hayatına konfor katacak, çevreye duyarlı, modern yaşam alanları oluşturmak için hayat bulan Eliz Cam Sistemleri başarılarla dolu yolculuğuna 2008 yılında başlamıştır. **Hayata kalıcı ve güvenli izler** bırakmayı kendine vizyon olarak belirleyen Eliz Cam Sistemleri; sektöre birçok yeniliği getiren ürünlerin de mimarı olmuştur.

Kuruluşundan bu yana artan ivmesi, insan odaklı kurum felsefesi ve geldiği noktadaki konumu itibarıyla yarınlara güçlü adımlarla yürüyen Eliz Cam Sistemleri, bu ülkenin gururla anılacak, küresel oyuncusu olma hedefine her geçen gün biraz daha yaklaşmaktadır.

ABOUT US

The successful journey of Eliz Glass Systems started in 2008 to create environmentally conscious, modern living spaces that will add comfort to human life. Eliz Glass Systems aims the vision to leave **permanent and reliable marks in life** has been the architect of the sector with different products introducing innovation.

Increasing acceleration of the firm, human-centric corporate philosophy and current position since the first day of the establishment have enabled Eliz Glass Systems to take strong steps forward to the future and gets the firm one step closer to the target to be the global player.

DELTA SERİSİ / SERIES

KÜPEŞTE CAM SİSTEMLERİ
RAIL GLASS SYSTEM



DELTA SERİSİ / SERIES

Deltatech 101 - Deltaterm 311 Korkuluk Sistemi Deltatech 101 - Deltaterm 311 Railing System

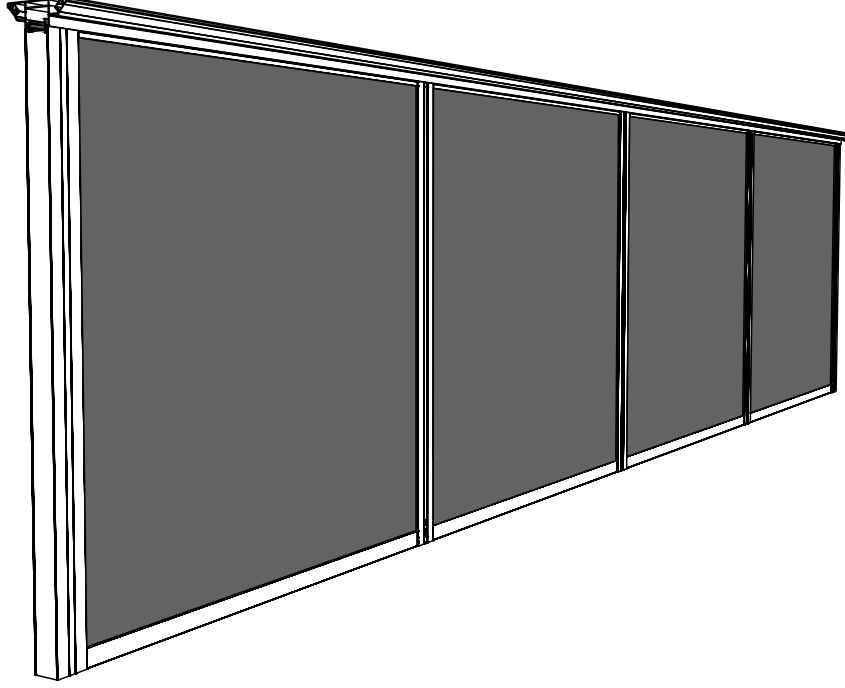

Uygulandığı her alanda ferah bir atmosfer yaratan Delta serisi, yaşam alanlarını olumsuz koşullardan koruyarak şık bir alana dönüştürür. Temperli ve temperli lamine cam özelliği ve güçlü yapısıyla hemen hemen her alanda kullanıma uygun olan Delta serisi, dışarıyla aranıza set koymadan enerjik bir ortam oluşturmanıza olanak sağlar. İhtiyaca göre projelendirilebilen Delta serisi açık alan kullanımınıza da maksimum düzeye çıkarır. Deltatech 101 sisteminde 10mm temperli, 5+5mm temperli lamine ve 6+6mm lamine cam, Deltaterm 311 sisteminde ise 4+20hb+4mm temperli ısıcam seçenekleri bulunmaktadır. Ayrıca Deltaterm 311 serisinde hasarlı cam değişimi kolaylıkla yapılabildiği gibi geniş küpeşte profili ve küpeşte uzatma profilleri ile üzerine sürme cam sistemlerini rahatça uygulayabilirsiniz.

Creating a spacious atmosphere in every application area, Delta series protects living spaces from negative conditions and turns them into a stylish space. With its tempered and tempered laminated glass feature and strong structure, Delta series, which is suitable for use in almost every area, allows you to create an energetic environment without putting a set between you outside. The Delta series, which can be designed according to the needs, also maximizes your outdoor use. Deltatech 101 system has 10mm tempered, 5 + 5mm tempered laminated and 6 + 6mm laminated glass, and Deltaterm 311 system has 4 + 20hb + 4mm tempered insulating glass options. In addition, in the Deltaterm 311 series, damaged glass replacement can be made easily, and you can easily apply sliding glass systems with wide handrail profile and handrail extension profiles.

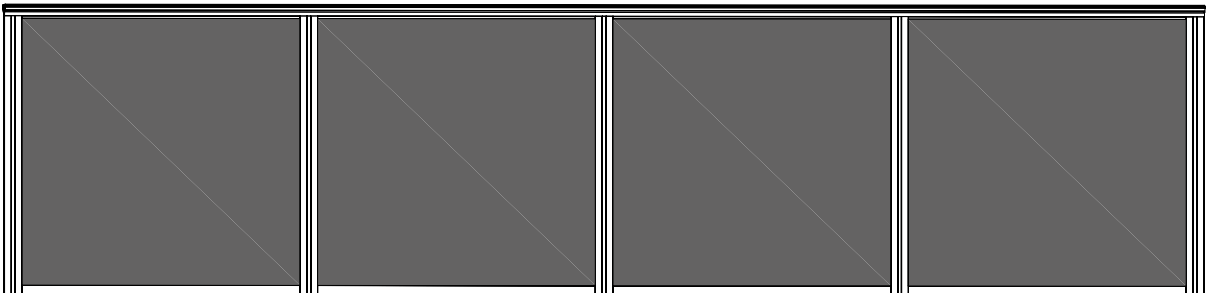

Deltatech 101 - Deltaterm 311 Korkuluk Sistemi Deltatech 101 - Deltaterm 311 Railing System

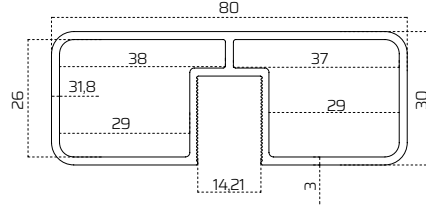

K peŐte Profili / Gunwale Profile

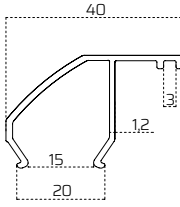

GeniŐ   Çıta Profili / Wide Internal Slat Profile

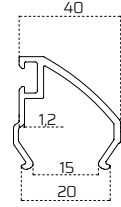

Dar  ta Profili / Narrow Slat Profile

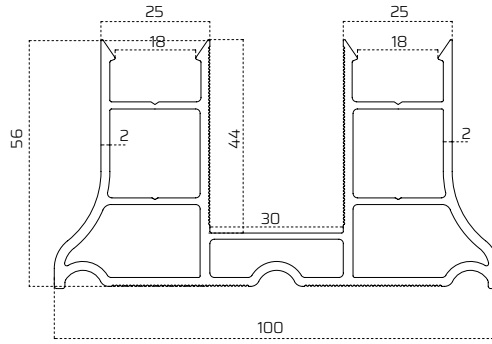

Baza Profili / Base Profile

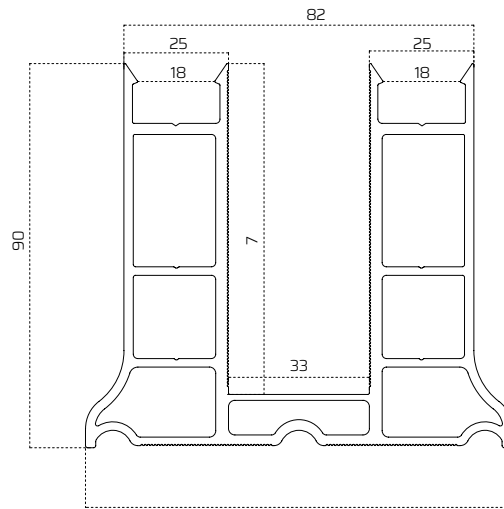

B y k Baza Profili / Big Base Profile

Deltatech 101 Korkuluk Sistemi Deltatech 101 Railing System

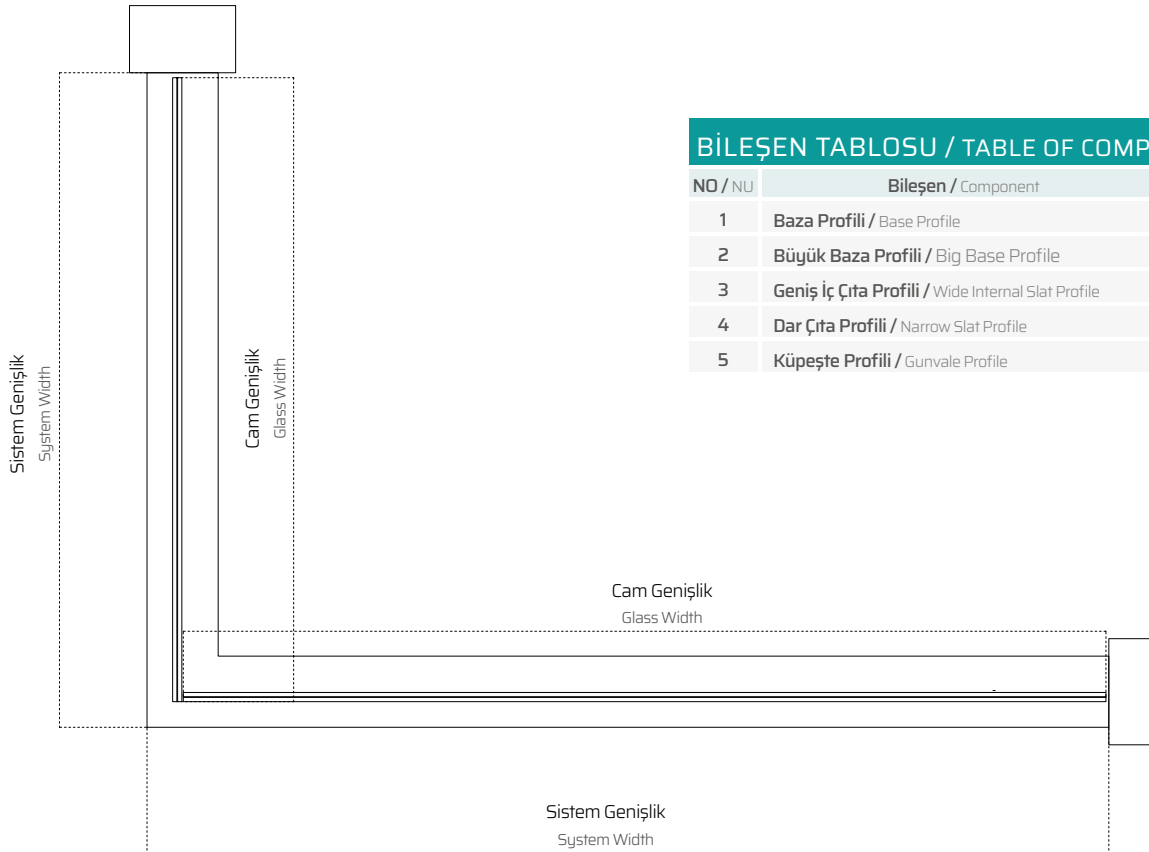
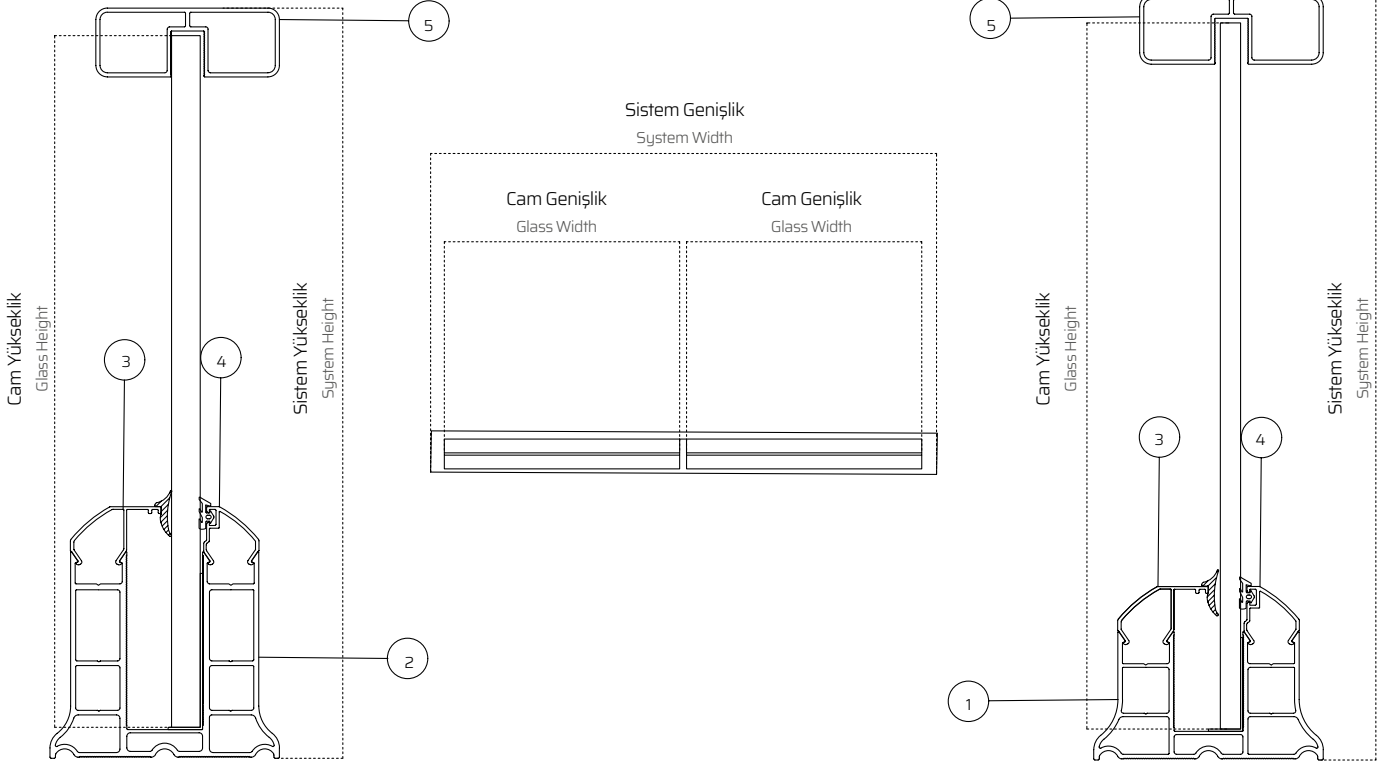

BİLEŞEN TABLOSU / TABLE OF COMPONENTS

NO / NU	Bileşen / Component	Kod / Code
1	Baza Profili / Base Profile	601101
2	Büyük Baza Profili / Big Base Profile	601104
3	Geniş İç Çita Profili / Wide Internal Slat Profile	601103
4	Dar Çita Profili / Narrow Slat Profile	601102
5	Küpeşte Profili / Gunvale Profile	601105

Deltaterm 311 Korkuluk Sistem Profil Grubu Deltaterm 311 Railing Group of Single Glass Profile

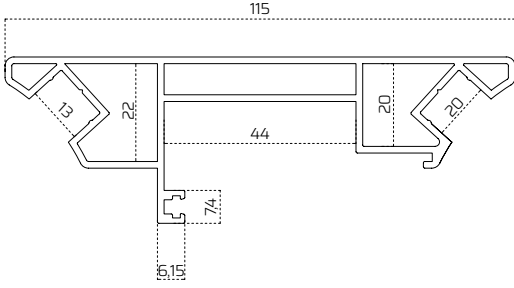

Küpeşte Profili / Gunwale Profile

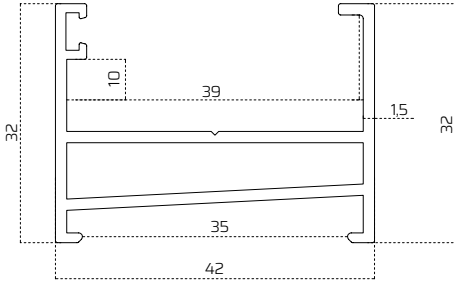

Alt Baza Profili / Lower Base Profile

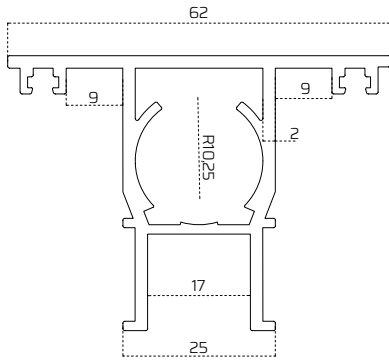

Alt Baza Profili / Lower Base Profile

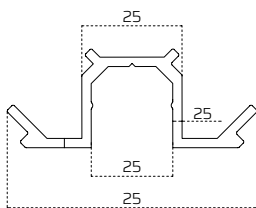

Köşe Dikme Kapak Profili / Corner Sewing Cover Profile

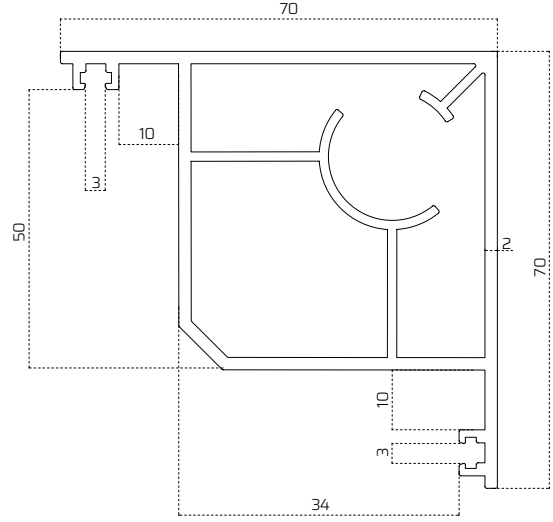

Küpeşte Köşe Profili / Gunwale Corner Profile

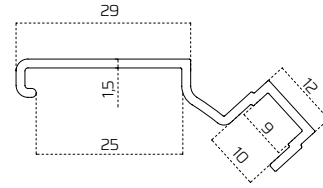

Küpeşte Uzatma Profili / Gunwale Extension Profile

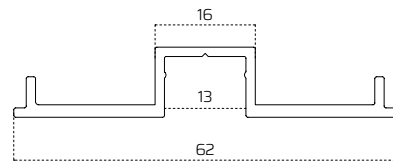

Dikme Kapak Profili / Sewing Cover Profile

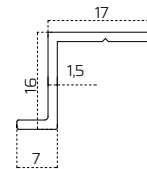

Küpeşte Kapak Profili / Gunwale Cover Profile
0,091 Kg/m

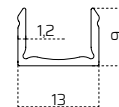

Vida Gizleme Profili / Screw Hiding Profile

Deltaterm 311 Korkuluk Sistemi Deltaterm 311 Railing System

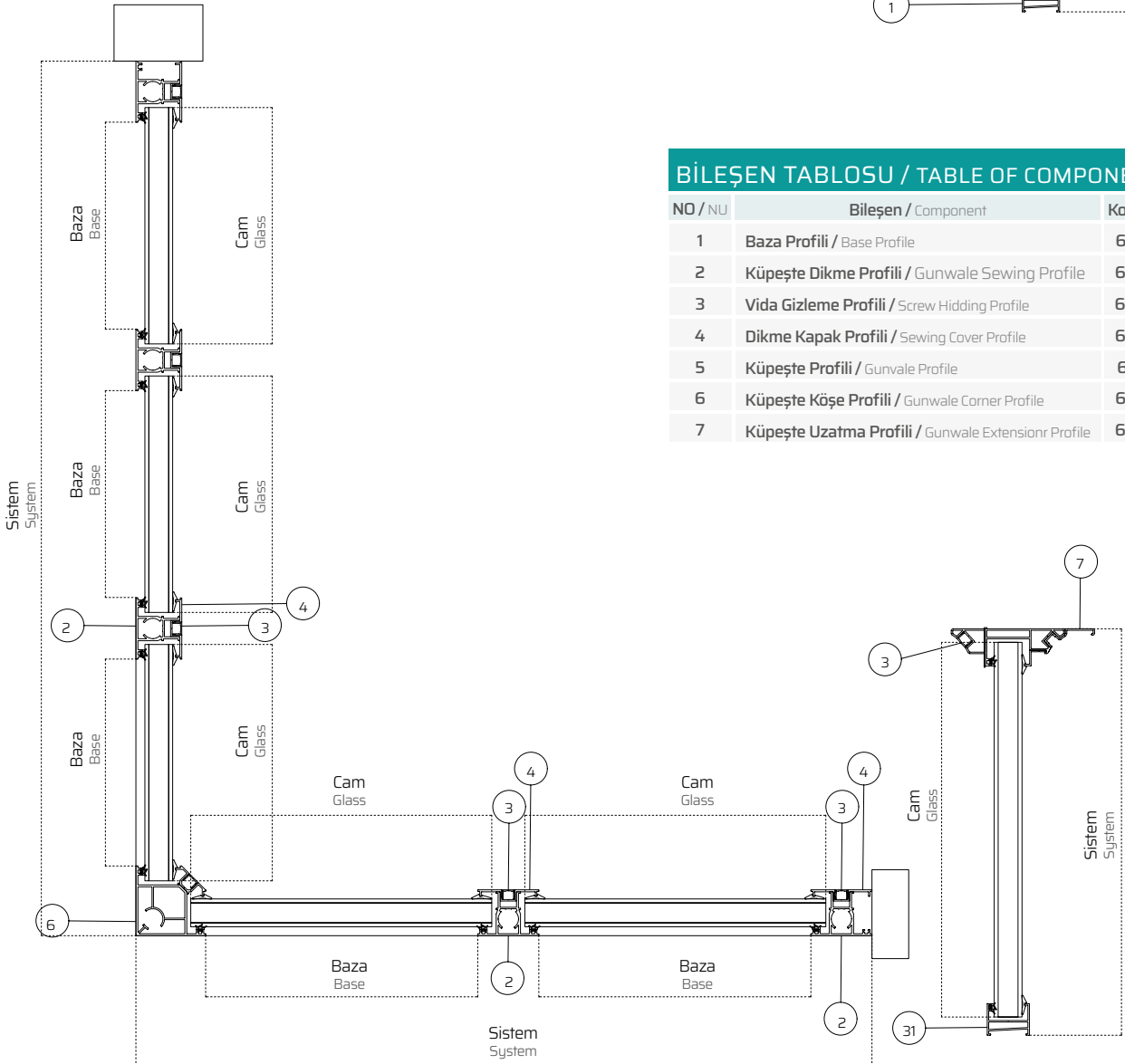
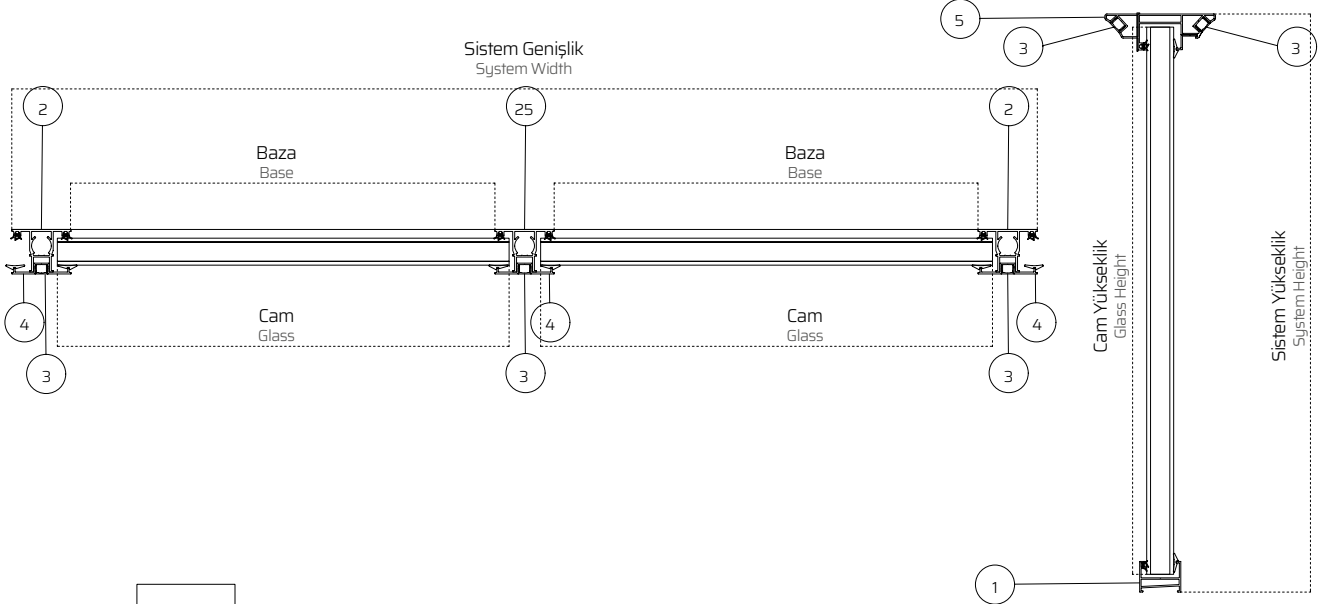

BİLEŞEN TABLOSU / TABLE OF COMPONENTS

NO / NU	Bileşen / Component	Kod / Code
1	Baza Profili / Base Profile	602107
2	Küpeşte Dikme Profili / Gunwale Sewing Profile	602106
3	Vida Gizleme Profili / Screw Hidding Profile	602108
4	Dikme Kapak Profili / Sewing Cover Profile	602104
5	Küpeşte Profili / Gunwale Profile	602101
6	Küpeşte Köşe Profili / Gunwale Corner Profile	602105
7	Küpeşte Uzatma Profili / Gunwale Extension Profile	602109

Deltatech 101 Korkuluk Sistemi Montaj Şeması Deltatech 101 Railing System Assembly Scheme

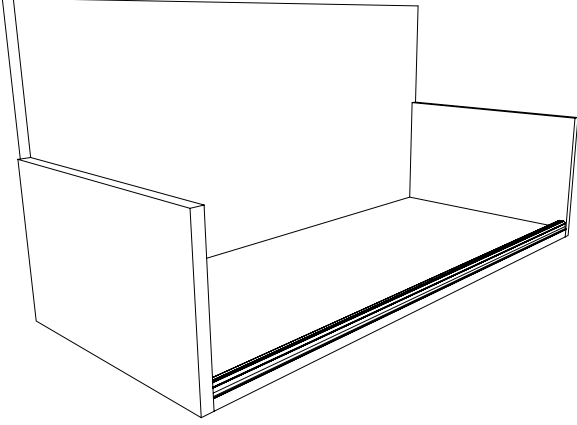

ADIM - 1 / STEP - 1

Baza yerleştirilir

Base profile is placed

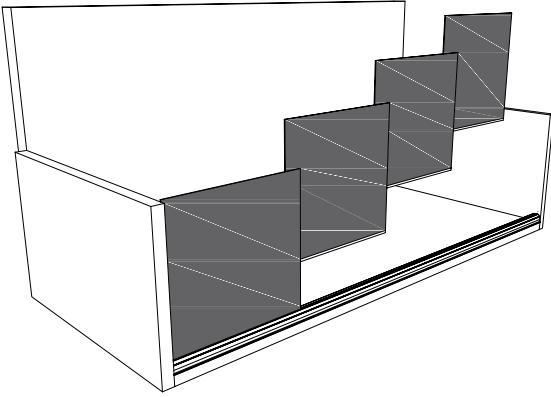

ADIM - 2 / STEP - 2

Camlar yerleştirilir

Glasses are placed

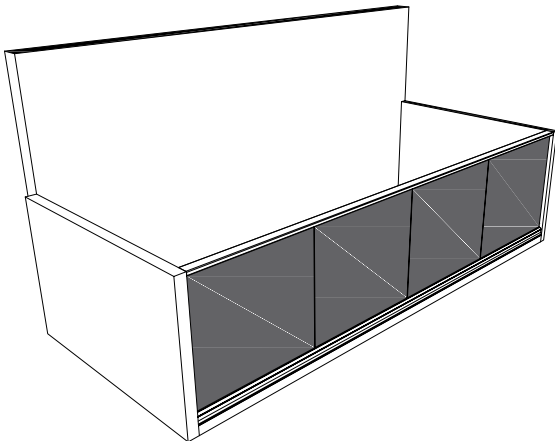

ADIM - 3 / STEP - 3

Kapaklar takılır

Gunwale is placed

Deltaterm 311 Korkuluk Sistemi Montaj Şeması

Deltaterm 311 Railing System Assembly Scheme

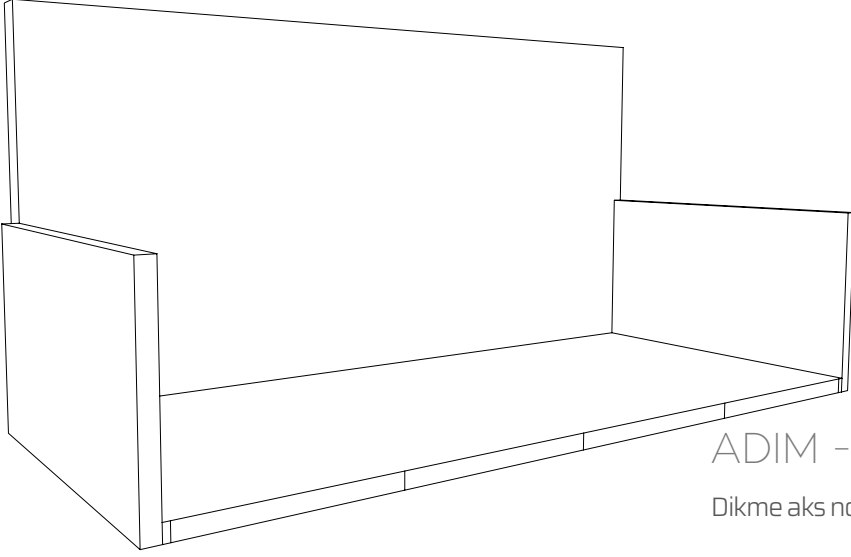

ADIM - 1 / STEP - 1

Dikme aks noktaları belirlenir

Strut axle points are determined

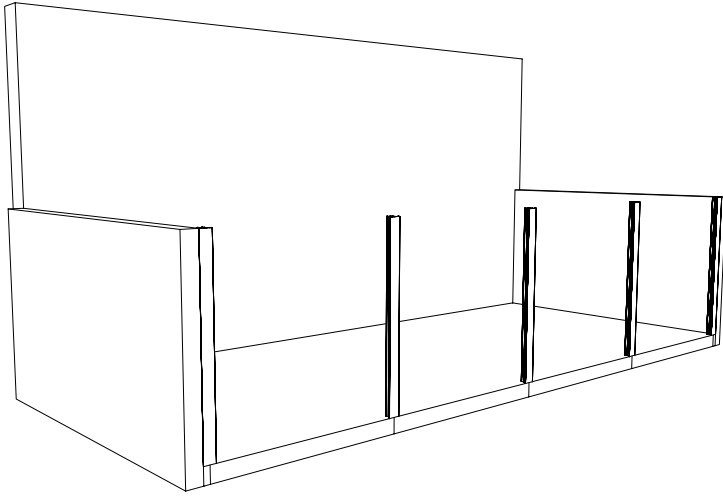

ADIM - 2 / STEP - 2

Dikmeler yerleştirilir

Strut are placed

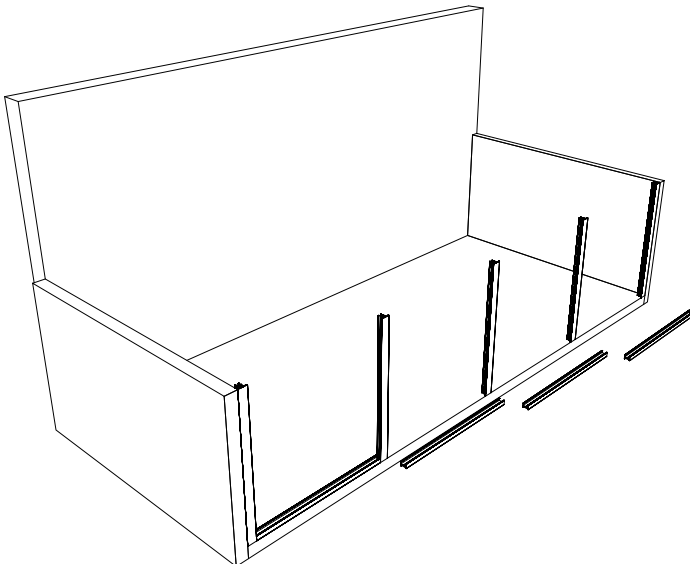

ADIM - 3 / STEP - 3

Bazalar yerleştirilir

Bases are placed

Deltaterm 311 Korkuluk Sistemi Montaj Şeması Deltaterm 311 Railing System Assembly Scheme

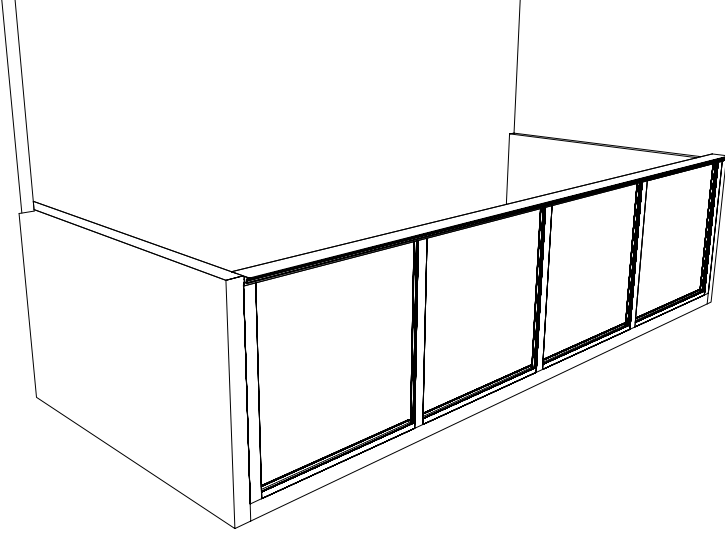

ADIM - 4 / STEP - 4

Üst Küpeşte yerleştirilir

Gunwale profile is placed

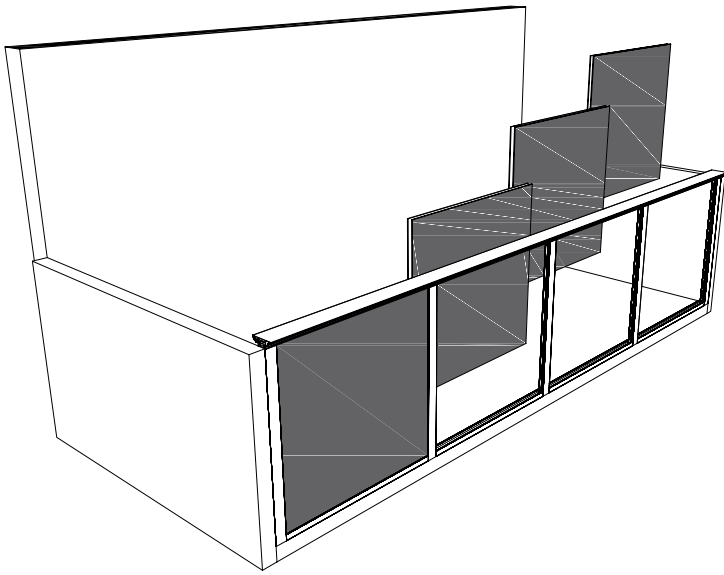

ADIM - 5 / STEP - 5

Camlar yerleştirilir

Glasses are placed

Deltaterm 311 Korkuluk Sistemi Montaj Şeması Deltaterm 311 Railing System Assembly Scheme

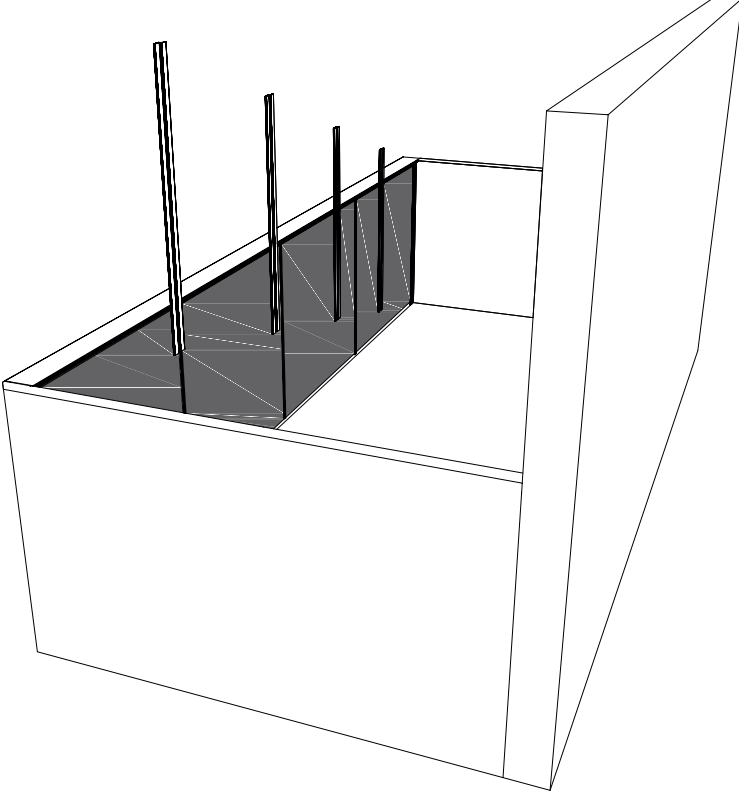

ADIM - 6 / STEP - 6

Kapaklar takılır

Covers are placed

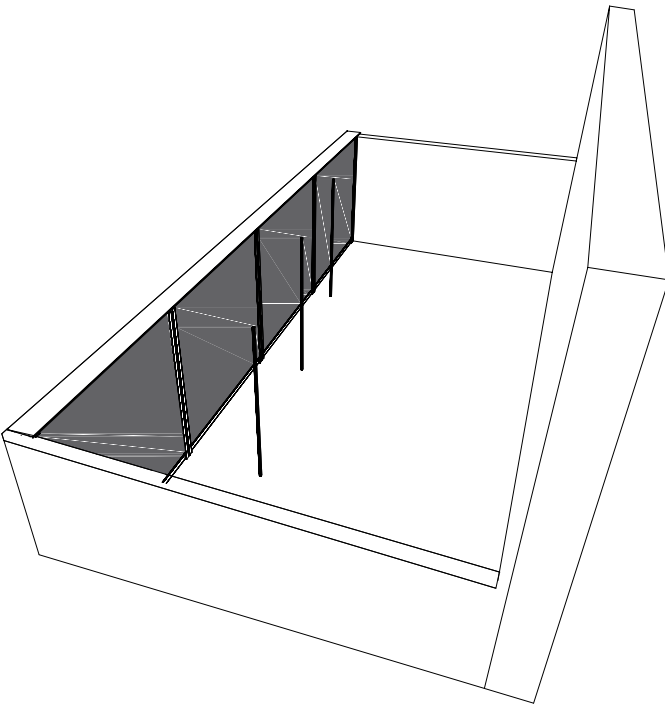

ADIM - 7 / STEP - 7

Vida gizleme profilleri takılır

Screw hidden profiles are placed



DELTA SERİSİ / SERIES

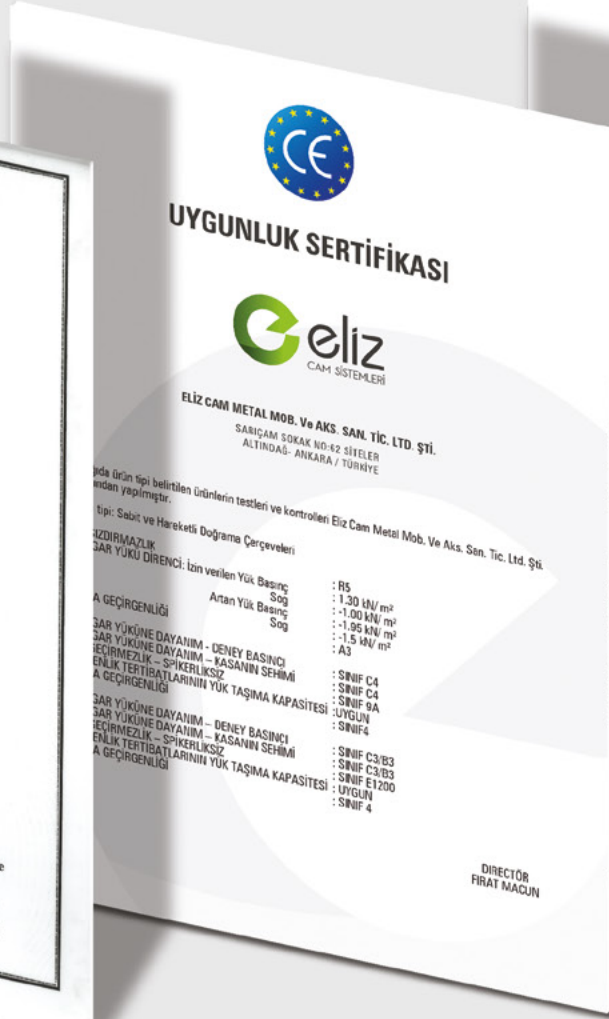



Karpuzlu 1 Cad. No:5 Siteler Altındağ/ANKARA

T: 0312 353 75 71 • **F:** 0312 348 44 99

bilgi@elizcam.com.tr